

Installation and Operating Instructions

Model:

HX-2-2NF-CER-T



For your convenience, we recommend to attach
the serial number label HERE.

As part of Parmco Appliances commitment to improving and updating product ranges,
we reserve the right to alter, change and update technical specifications and appearance
attributes of all Parmco Appliances products. E&OE

727626052018

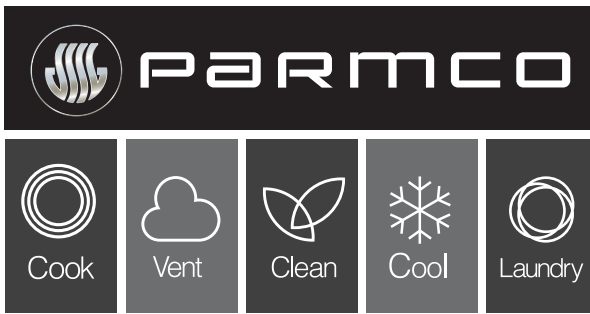

p: 09 573 5678
 f: 09 573 5699
 e: sales@parmco.co.nz
 w: www.parmco.co.nz

*Parmco Appliances
 extended 7 year
 warranty*



The Warranty:

- This appliance is intended for domestic use in the owners' home. Use of the appliance for commercial purposes will limit the warranty period (please see Parmco website for commercial details).
- Subject to the terms and conditions contained within this warranty, if the product is not of Acceptable Quality (as defined in the Consumer Guarantees Act) within 7 years of the date of original purchase, then Parmco Sales undertakes to repair or, at its sole discretion, replace the product.
- The warranty does not cover the costs of transport, mileage or travelling time if the product is located beyond 30km of a recognised Service Agent.
- This warranty is offered as an extra benefit, and does not affect other legal rights, which can not be modified or excluded by agreement.
- This warranty only applies to goods supplied and installed in the North and South Islands of New Zealand.
- The provisions of this warranty are in addition to the rights and remedies available to consumers under the Consumer Guarantees Act 1993.

The Warranty is not valid:

- If the product is not installed and operated in accordance with the operating instructions.
- If the product is not installed to comply with the electrical, gas, plumbing and other Regulations and Codes of Practice in New Zealand.
- If the product is operated on voltages or frequencies outside the normal range for domestic appliances in New Zealand.
- If the product is not used in normal domestic use, or if it is used in a business as defined in the Consumer Guarantees Act.
- If any serial number has been removed or defaced.
- If proof of date of purchase is not supplied, except at the sole discretion of Parmco Sales. Proof of purchase can be for the product itself, or if installed with a kitchen or house then proof of purchase can be from a Parmco reseller of products supplied by Parmco.
- If the products are purchased in a second hand condition from other parties (including but not limited to TradeMe, Sella, etc.)

Liability under this warranty will not be accepted for:

- Wear and tear caused by normal domestic use of the product.
- Damage in transport.
- Damage caused to the product by neglect, abuse, negligence, wilful act or misuse.
- Any costs associated with the repair, replacement, removal or reinstallation of products installed in a damaged condition.
- Any defect caused by accident, misuse, neglect, tampering with or unauthorised modifications of the appliance or any attempt at internal adjustment or repair by any person other than an Authorised Service Agent.
- Service calls that relate principally to the following:
 - Instruction on how to use the product.
 - Repair or replacement of house fuses, electrical wiring, gas fitting or plumbing.
 - Normal or scheduled maintenance including blocked filters or ducting.
 - Consumable items such as light bulbs.
 - Any damage to hobs caused by spills when cooking.
 - Any breakage or damage of glass items.
 - Any damage caused by non recommended product used for cleaning, maintaining, lubricating or similar.
 - Any aspect relating to the installation of the product, or damage caused during installation including blocked access for repair.
 - Any third party (including reseller) or consequential loss or damage (direct or indirect) however arising.

Product _____ Date of purchase _____
 Serial Number _____
 Dealer / Retailers Name _____

 Please retain this Warranty card together with receipt or other proof of purchase date when seeking service during the warranty period

Please contact Parmco at 09 573 5678 if your appliance needs servicing under warranty. Please have your model number and proof of purchase ready. Warranty repairs must be authorized by Parmco.

Subject to updates without prior notice, please visit www.parmco.co.nz for the latest version.



PARMCO

Dear Valued Customer,

Thank you and congratulations on purchasing your new Parmco appliance.

All Parmco products are made to the highest quality and design standards. We are sure you will enjoy your new appliance.

As a note, please read through these instructions carefully. These will assist you in gaining a complete understanding of the functions and features offered by your appliance. Please take special note of all detailed technical information and installation instructions. It is essential that you follow these instructions to ensure the safety and reliability of this appliance.

Furthermore, not using appropriate personnel to install this appliance may affect any future warranty claims lodged, so please check with Parmco Appliances before any installation is carried out.

We hope you enjoy your new appliance. If you would like to find out more about this product or any other products in Parmco's extensive range, visit us online at www.parmco.co.nz.

Regards,

The Parmco Team

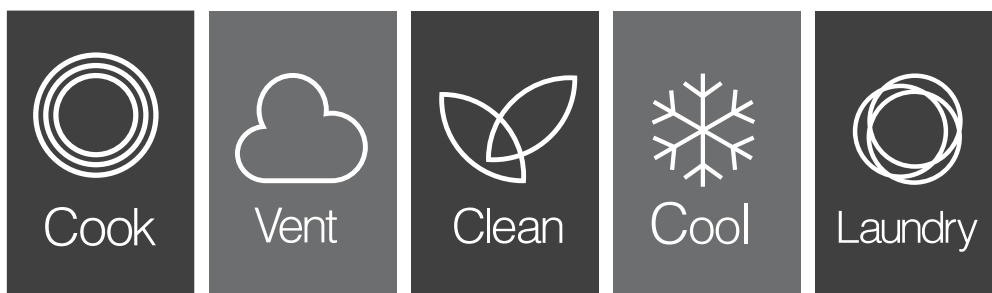

INDEX

Important Safety Warnings	2
Product overview	5
Top view	5
Control panel	5
Before using your Ceramic Hob	6
Using your Ceramic Hob	7
To start cooking	7
When you have finished cooking	8
Locking the Controls	9
Using the Timer	9
Auto Shutdown	11
Cooking guidelines	11
Heat settings	12
Care and cleaning	13
Troubleshooting	14
Technical Specifications	15
Installation	16

Important Safety Warnings

1. If the supply cord is damaged, it must be replaced by the manufacturer, its service agent or similarly qualified persons.
2. This product is intended for indoor use only.
3. Power line connection: The power cord must be connected in compliance with the relevant New Zealand standards.
4. If the appliance is being connected directly to the mains an Omni-polar circuit-breaker must be installed with a minimum opening of 3mm between contacts.
5. Please use a dedicated power protection switch.
6. Do not wash the ceramic plate directly with water as excess water entering the hob is a hazard. Wipe it with a damp cloth instead.
7. Do not use the ceramic hob with an empty pan as this will affect its operational performance and may damage the unit.
8. Do not heat unopened canned goods directly on the ceramic hob as there is a danger of explosion due to heat expansion.
9. After being in use for a long time, the corresponding heating zone of the ceramic plate will be hot. Do not touch the ceramic surface to avoid personal injury.
10. We suggest you periodically check that there are no objects (glass, paper, etc) that could obstruct the ventilation inlets under your ceramic hotplate.
11. Metallic objects such as knives, forks, spoons and lids should not be placed on the hotplate since they will get hot.
12. If the surface is cracked, switch off the appliance and contact Parmco Appliances. To avoid the possibility of an electric shock do not continue to use a damaged hob.
13. This appliance is not intended for use by persons (including children) with reduced physical, sensory or mental capabilities or lack of experience and knowledge unless they have been given supervision or instruction concerning use of the appliance by a person responsible for their safety.
14. Children should be supervised to ensure that they do not play with the appliance.
15. **WARNING:** Accessible parts may become hot during use. Young children should be kept away.
16. This appliance is not intended to be operated by means of an external timer or separate remote-control system.

17. After use switch off the hob element at its control.
18. Shall state a steam cleaner is not be used.
19. CAUTION: The surface temperature exceeds 95°C. To avoid a hazard, under bench access must be restricted. Refer to the installation instructions.
20. WARNING: The appliance and its accessible parts become hot during use. Care should be taken to avoid touching heating elements.
Children less than 8 years of age shall be kept away unless continuously supervised.
21. WARNING: Unattended cooking on a hob with fat or oil can be dangerous and may result in fire. NEVER try to extinguish a fire with water, but switch off the appliance and then cover flame e.g. with a lid or a fire blanket.
22. WARNING: Danger of fire: do not store items on the cooking surfaces.
23. CAUTION: The cooking process has to be supervised. A short term cooking process has to be supervised continuously.
24. WARNING: Use only hob guards designed by the manufacturer of the cooking appliance or indicated by the manufacturer of the appliance in the instructions for use as suitable or hob guards incorporated in the appliance. The use of inappropriate guards can cause accidents.

Other Safety Precautions

Your safety is important to us. Please read this information before using your cooktop.

- No combustible material or products should be placed on this appliance at any time.
- In order to avoid a hazard, this appliance must be installed by an authorised electrician according to these instructions.
- This appliance should be connected to a circuit which incorporates an isolating switch providing full disconnection from the power supply.
- Failure to install the appliance correctly could void the warranty or liability claims.

Installation

Electrical Shock Hazard

- Disconnect the appliance from the mains electricity supply before carrying out any work or maintenance on it.
- Connection to a good earth wiring system is mandatory.
- Alterations to the domestic wiring system must only be made by a qualified electrician.
- Failure to follow this advice may result in electrical shock or death.

Operation and maintenance precautions

Hot Surface

- During use, accessible parts of this appliance may become hot enough to cause burns.
- Do not let your body, clothing or any item other than suitable cookware contact the glass until the surface is cool.
- Never leave metal objects (such as kitchen utensils) or empty pans on the cooktop as they can become hot very quickly.
- Failure to follow this advice could result in burns and scalds.

General precautions

- Never leave the appliance unattended when in use. Spillovers can cause smoking and greasy spillovers may ignite.
- Never use your appliance as a work or storage surface.
- Never leave any objects or utensils on the appliance.
- Never use your appliance for warming or heating the room.
- After use, always turn off the cooking zones and the cooktop as described in this manual (i.e. by using the touch controls).
- Do not repair or replace any part of the appliance unless specifically recommended in the manual. All other servicing should be done by a qualified technician.
- Do not use a steam cleaner to clean your cooktop.
- Do not place or drop heavy objects on your cooktop.
- Do not stand on your cooktop.
- Do not use pans with jagged edges or drag pans across the glass surface as this can scratch the glass.
- Do not use scourers or any other harsh abrasive cleaning agents to clean your cooktop, as these can scratch the glass.

Product Overview

Top View



Control Panel

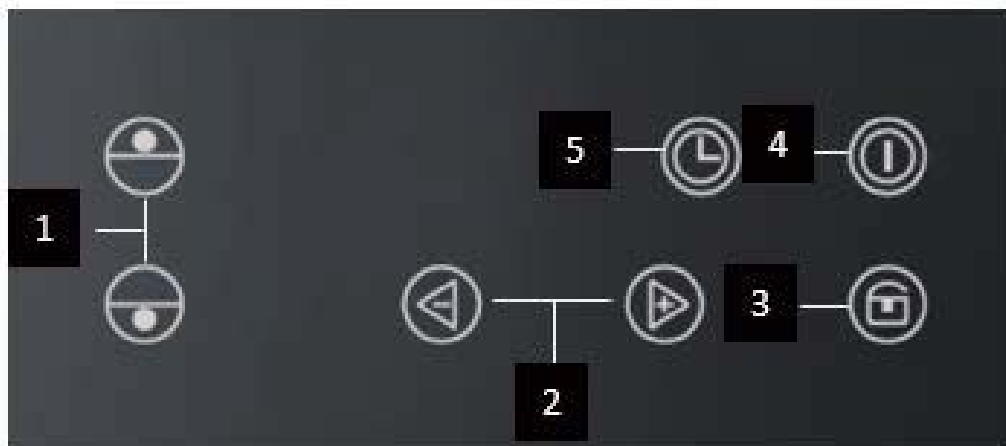

1. Heating zone selection controls
2. Heating/Timer regulating controls
3. Key-lock/Child-lock control
4. ON/OFF control
5. Timer control

Before using your Ceramic Hob

- Read this guide, taking special note of the 'Safety Warnings' section.
- Remove any protective film that may still be on your ceramic hob.

Using the Touch Controls

- The controls respond to touch, so you do not need to apply any pressure.
- Use the ball of your finger, not its tip.
- You will hear a beep each time a touch is registered.
- Make sure the controls are always clean, dry and that there is no object (e.g. a utensil or a cloth) covering them. Even a thin film of water may make the controls difficult to operate.

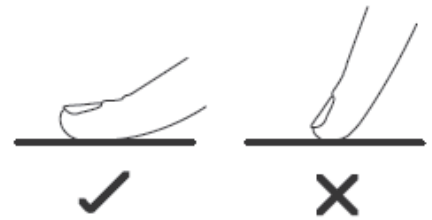

Choosing the right Cookware

Do not use cookware with jagged edges or a curved base.



Make sure that the base of your pan is smooth, sits flat against the glass, and is the same size as the cooking zone. Always centre your pan on the cooking zone.

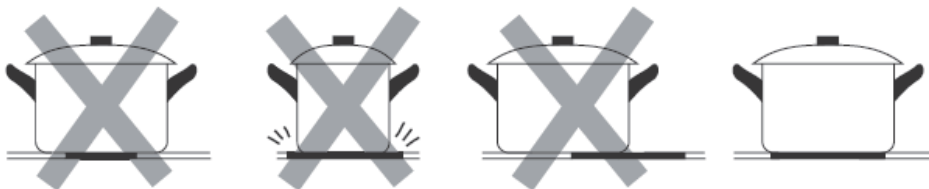

Always lift pans off the ceramic hob – do not slide, as they may scratch the glass.

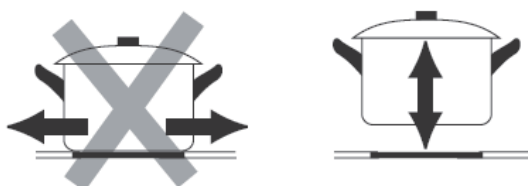

Using your Ceramic Hob

To start cooking

1. Touch the ON/OFF  control. All the indicators show “0” or “00”
 - Once powered on, the buzzer beeps once, indicating that the ceramic hob is now on.

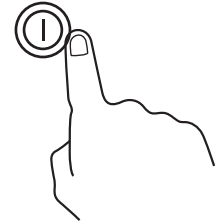

2. Place a suitable pan on the cooking zone that you wish to use.
 - Make sure the bottom of the pan and the surface of the cooking zone are clean and dry.

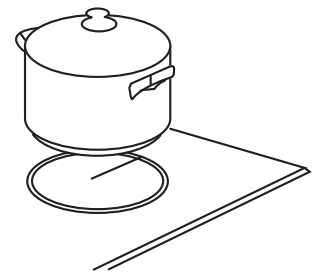

3. Touch the heating zone selection control. An indicator will light up

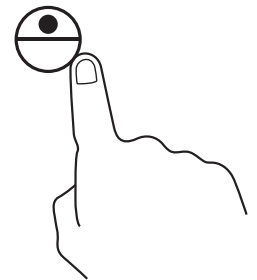

4. Select a heat setting by touching the “-” or “+” controls.

- If you don't choose a heat setting within 1 minute, the ceramic hob will automatically switch off. You will need to start again from step 1.
- You can modify the heat setting at any time during cooking by holding down/pressing either of these buttons to adjust the temperature up or down.

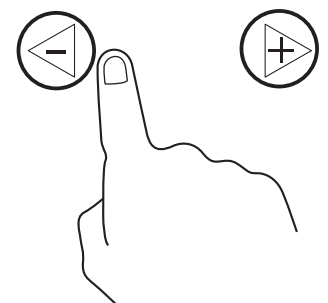

Note: If using multiple heating zones, to change the heat setting, simply touch the heating zone control you desire, then use the “-” or “+” controls to change the heat setting.

When you have finished cooking

1. Touch the heating zone selection control that you wish to switch off.

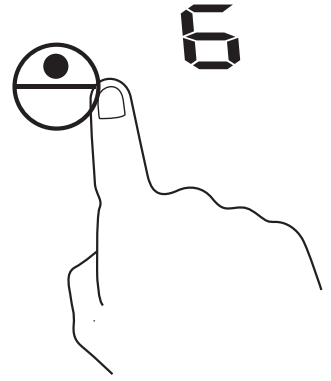

2. Turn the cooking zone off by scrolling down to "0" using the "-" key on your power regulating control. The display will then show "H"

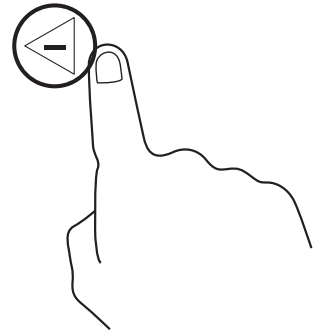

3. Turn the whole cooktop off by touching the ON/OFF control.

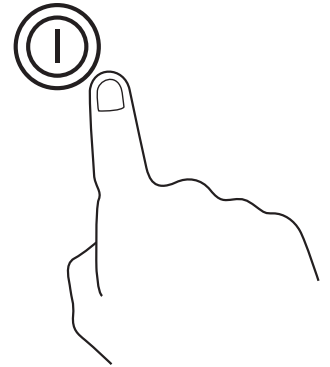

4. Beware of hot surfaces

- "H" will show which cooking zone is still hot to touch. The signal will disappear when the surface has cooled down to a safe temperature. It can also be used as an energy saving function - if you want to heat further pans, use the hotplate that is still hot.



Locking the Controls

You can lock the controls to prevent unintended use (for example children accidentally turning the cooking zones on).

When this function is activated, all controls except the ON/OFF control are disabled.

To lock the controls

1. Touch and hold the  keylock symbol to lock the hob control panel.

To unlock the controls

1. Make sure the ceramic hob is turned on.
2. Touch and hold the keylock  control to unlock the hob control panel.
3. The hob is now unlocked, and you can now start using it.



When the hob is in lock mode, all controls are disabled except the ON/OFF control. In an emergency, you can turn the ceramic hob off with the ON/OFF button, but you will have to unlock the hob first before the next use.

Using the Timer

You can use the timer to turn one or more cooking zones off after a set amount of time.

Note: The timer can be set for up to 99 minutes.

Setting the timer to turn one heating zone off

1. Touch the heating zone selection control corresponding to the zone that you want to set the timer for.

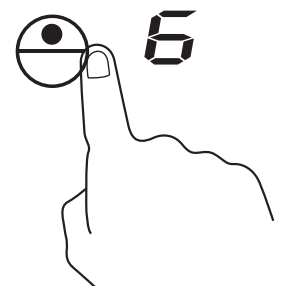

2. Select the heat level using the “-“ or “+” regulating controls.

3. Touch the timer control.

4. Set the time by touching the “-“ or “+” regulating controls. Time will change in increments of 1 minute.

- If the setting time exceeds 99 minutes, the timer will automatically return to 0 minutes.

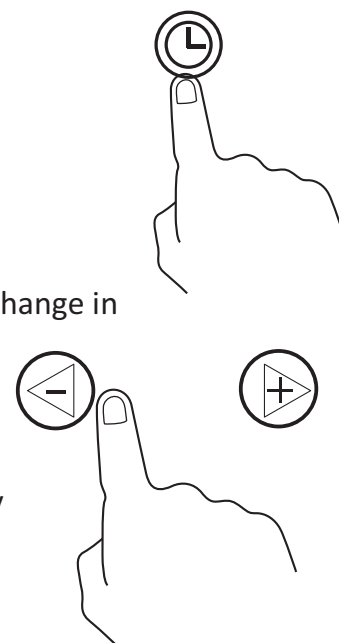

Cancelling the timer for a heating zone

1. Press the “-“ timer regulating key to reduce the time outstanding to 0.

NOTE: The red dot next to power level indicator will illuminate indicating that zone is selected.



When the selected cooking time has been reached, the corresponding cooking zone will switch off automatically.

Other heating zone will keep operating if it had previously been turned on.

Auto Shutdown

Auto shut down is a safety protection function for your ceramic hob. It shuts down automatically if you ever forget to turn off a cooking zone. The default shutdown times for various power levels are shown in the table below:

Power level	1	2	3	4	5	6	7	8	9
Default working timer (hour)	6	6	5	5	4	1.5	1.5	1.5	1.5

Cooking Guidelines

Cooking Tips

- When food comes to the boil, reduce the temperature setting.
- Using a lid will reduce cooking times and save energy by retaining the heat.
- Minimize the amount of liquid or fat to reduce cooking times.
- Start cooking on a high heat setting then reduce the heat once the food has heated through.

Simmering, cooking rice

- Simmering occurs below boiling point, at around 85°C, when bubbles are just rising occasionally to the surface of the cooking liquid. It is the key to delicious soups and tender stews as the flavours develop without overcooking the food.
- Some items, including cooking rice by the absorption method, may require a setting higher than the lowest setting to ensure the food is cooked properly in the time recommended.

Searing steak

To cook juicy steaks:

1. Stand the meat at room temperature for about 20 minutes before cooking.
2. Heat up a heavy-based bottom frying pan.
3. Brush both sides of the steak with oil. Drizzle a small amount of oil into the hot pan and then lower the meat onto the pan.
4. Turn the steak only once during cooking. The exact cooking time will depend on the thickness of the steak and the desired degree of cooking. Times may vary between 2 – 8 minutes per each

side. Press the steak to gauge how cooked it is – the firmer it feels the more ‘well done’ it will be.

5. Leave the steak to rest on a warm plate for a few minutes before serving.

Stir-frying

1. Choose a ceramic compatible flat-based wok or a large frying pan.
2. Have all the ingredients and equipment ready. Stir-frying should be quick. If cooking large quantities, cook the food in several smaller batches.
3. Preheat the pan briefly and add two tablespoons of oil.
4. Cook any meat first, then put it aside and keep warm.
5. Stir-fry the vegetables. When they are hot but still crisp, turn the cooking zone to a lower setting, return the meat to the pan and add your sauce.
6. Stir the ingredients gently until they are heated through. Serve immediately.

Heat Settings

The settings below are guidelines only. The exact setting will depend on several factors, including your cookware and the amount you are cooking. Experiment with the cooktop to find the settings that best suit you.

Heat setting	Suitability
1 - 2	<ul style="list-style-type: none">• delicate warming for small amounts of food• melting chocolate, butter, and foods that burn quickly• gentle simmering• slow warming
3 - 4	<ul style="list-style-type: none">• reheating• rapid simmering• cooking rice
5 - 6	<ul style="list-style-type: none">• pancakes
7 - 8	<ul style="list-style-type: none">• sautéing• cooking pasta
9	<ul style="list-style-type: none">• stir-frying• searing• bringing soup to the boil• boiling water

Care and Cleaning

What?	How?	Important!
<p>Everyday soiling on glass (fingerprints, marks, stains left by food or non-sugary spillovers on the glass)</p>	<ol style="list-style-type: none"> 1. Switch off the power to the cooktop at the wall. 2. Apply a non-abrasive ceramic cleaner while the glass is still warm (but not hot!), or simply wipe clean with a soft cloth and lukewarm water. 3. Rinse and wipe dry with a soft clean cloth or paper towel. 4. Switch the power to the cooktop back on. 	<ul style="list-style-type: none"> • When the power to the cooktop is switched off, there will be no 'hot surface' indication but the cooking zone may still be hot! Take extreme care. • Heavy-duty scourers, some nylon scourers and harsh/abrasive cleaning agents may scratch the glass. Always read the label to check if the cleaner or scourer is suitable. • Never leave cleaning residue on the cooktop: the glass may become stained.
<p>Boil-overs, melts, and hot sugary spills on the glass</p>	<p>Remove these immediately with a scraper suitable for ceramic glass cooktop, being careful of hot cooking zone surfaces.</p> <ol style="list-style-type: none"> 1. Switch off the power to the cooktop at the wall. 2. Hold the blade or utensil at a 30° angle and scrape the soiling or spill to a cool area of the cooktop. 3. Clean the soiling or spill up with a dish cloth or paper towel. 4. Follow steps 2 to 4 for 'everyday soiling on glass' above. 	<ul style="list-style-type: none"> • Remove stains left by melts and sugary food or spillovers as soon as possible. If left to cool on the glass, they may be difficult to remove or even damage the glass surface. • Cut hazard: The scraper blade is razor-sharp. Use with extreme care and always store safely and out of reach of children.
<p>Spillovers on the touch controls</p>	<ol style="list-style-type: none"> 1. Switch off the power to the cooktop at the wall. 2. Soak up the spill 3. Wipe the touch control area with a clean damp sponge or cloth. 4. Wipe the area completely dry with a soft cloth or paper towel. 5. Switch the power to the cooktop back on. 	<ul style="list-style-type: none"> • The cooktop may beep and turn itself off and the touch controls may not function while there is liquid on them. Make sure you wipe the touch control area dry before turning the cooktop back on.

Trouble Shooting

Problem	Possible causes	What to do
The cooktop cannot be turned on.	No power.	<p>Make sure the cooktop is connected to the power supply and that it is switched on.</p> <p>Check whether there is a power outage in your home or area.</p> <p>If you've checked everything and the problem persists, call a qualified technician.</p>
The touch controls are unresponsive.	The controls are locked.	Unlock the controls. See section 'Locking the Controls' for instructions.
The touch controls are difficult to operate.	<p>There may be a slight film of Water (or something) over the controls.</p> <p>You may be using the tip of your finger when touching the controls.</p>	<p>Make sure the touch control area clean and dry.</p> <p>Use the ball of your finger when touching the controls.</p>
The glass is being scratched.	<p>Rough-edged cookware.</p> <p>Cookware dragged across the cooktop surface.</p> <p>Unsuitable, abrasive scourer or cleaning products being used.</p>	<p>Use cookware with flat and smooth bases. See 'Choosing the right cookware' section.</p> <p>See 'Care and cleaning' section.</p>
Some pans make crackling or clicking noises.	This may be caused by the construction of your cookware (layers of different metals vibrating differently once heated).	This is normal for cookware and does not indicate a fault.
There is smoke when the hob is turned on.	This is normal when the hob is turned on for the first time.	Turn the hob off, let it cool and wipe it down with lukewarm water and soft cloth to remove all manufacturing residues.

Technical Specification

Model	HX-2-2NF-CER-T
Cooking Zones	2 Zones
Supply Voltage	220-240V~ 50Hz
Power	1200W (145mm)
	1800W (180mm)
Product Size L×W×H(mm)	300X520X68
Cut-out Dimensions (A x B)	280(L) X 496(W)

Dimensions are approximate. Because we continually strive to improve our products we may change specifications and designs without prior notice.



Installation

Dear Installer:

Please affix data label provided on the adjacent cupboard near the appliance for future reference. Thank you.

Selection of installation equipment

- Cut out the work surface according to the sizes shown in the drawing.
- For the purpose of installation and use, a minimum of 50mm space shall be preserved around the hole.
- Be sure the thickness of the work surface is at least 40-50mm. Please select heat-resistant work surface material to avoid larger deformation caused by the heat radiation from the hotplate.
- When installing the hob over drawers, a board must be installed 10mm underneath the hob. The board must be made of suitable heat resistant materials.

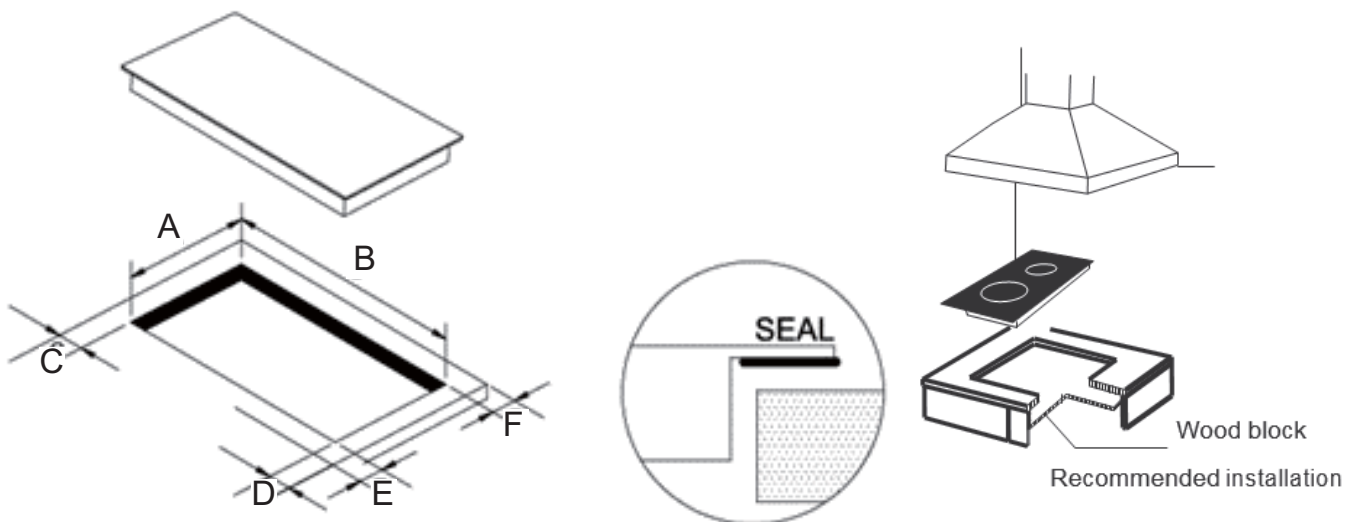

A	B	C	D	E	F
280mm	496mm	50mm min	50mm min	50mm min	50mm min



Make sure the hob is well ventilated and the air inlet and outlet are not blocked.

When installing a rangehood above an appliance, all relevant New Zealand building, installation and regulation standards must be adhered to.



Note: The safety distance between the ceramic hob and the cupboard above it or rangehood should be at least 650mm.

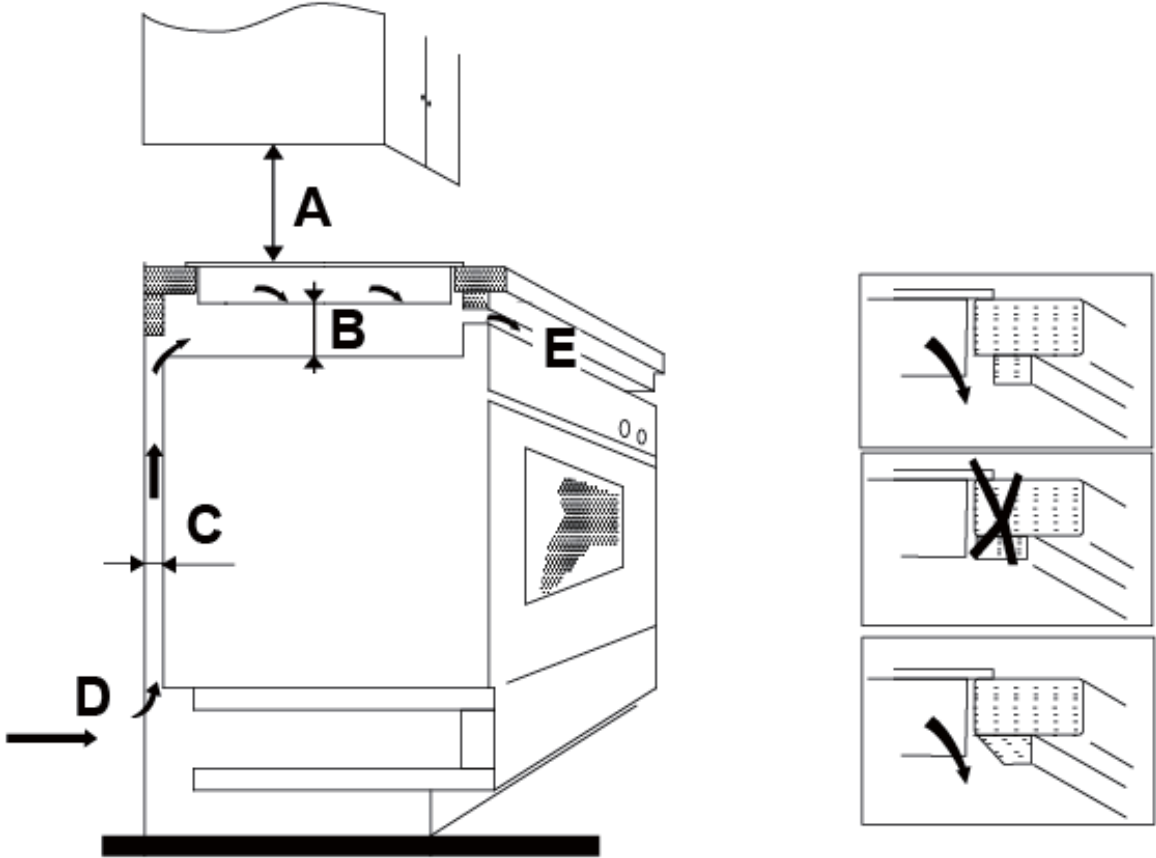

A(mm)	B(mm)	C(mm)	D	E
650	50 min	50 min	Air intake	Air exit 10 mm

Inserting and fixing the hob

Before inserting the hob into the work surface, place the adhesive seal around the underside edge of the hob. It is important to fix the seal evenly without gaps, to prevent liquids from seeping underneath the hob.

1. Turn the hob upside down (ensure the surface will not scratch the ceramic glass).
2. Place the gasket around the bottom edge of the hob.
3. Screw one end of the fixing brackets into the holes on the underside of the hob.
4. Place the hob into the work surface cutout, so it is sitting firmly on the surface.
5. Adjust the position of the brackets to suit the thickness of the work surface.
6. Screw the hob to the underside of the work surface using the other end of the fixing brackets already attached to the hob.

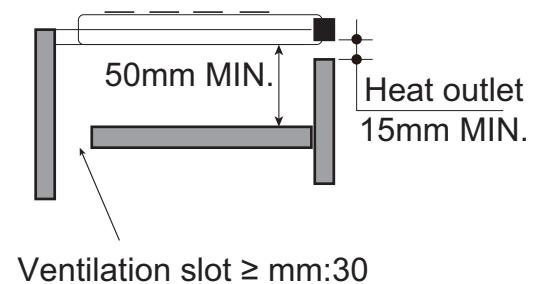
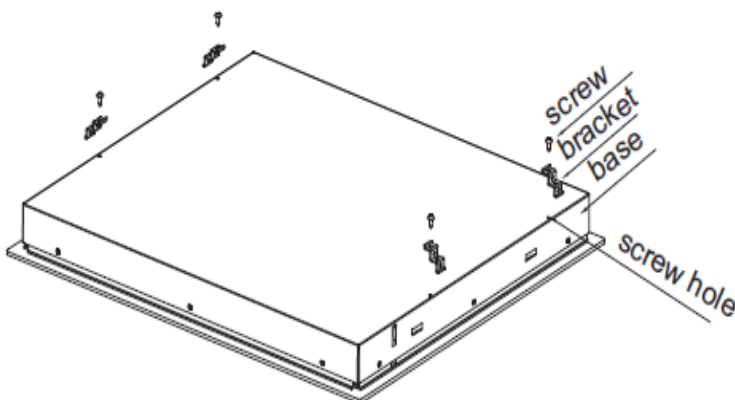



Cautions

- The hob must be installed by qualified personnel. Never conduct the operation by yourself.
- The hob shall not be mounted to cooling equipment, dishwashers and rotary dryers.
- The wall and induced heating zone above the work surface shall withstand heat.
- To avoid any damage, the benchtop and adhesive must be resistant to heat.
- A steam cleaner is not to be used for cleaning the product.

Connecting the hob to the mains power supply

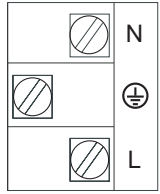
The power supply should be connected in compliance with the relevant local standards

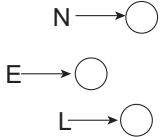
<p style="text-align: center;">CONNECTION DIAGRAM</p> <p>Caution! Voltage of heating elements 220-240V Caution! In the event of any connection the safety Wire must be connected to the  E terminal.</p>		<p>Recommended type of connection lead</p>
<p>For 220-240V earthed one-phase connection, bridges connect L terminals and N terminals, safety wire to </p>		

1. If the cable is damaged or needs replacing, the operation must be carried out by a qualified technician with dedicated tools to avoid any accidents.
2. The installer must ensure that the correct electrical connection has been made and that it is compliant with safety regulations.
3. The cable must not be bent or compressed.
4. The installer must use the supplied power cord.

Disposal



DISPOSAL: Do not dispose this product as unsorted municipal waste. Collection of such waste separately for special treatment is necessary.

This appliance is labeled in compliance with European directive 2012/19/EU for Waste Electrical and Electronic Equipment (WEEE). By ensuring that this appliance is disposed of correctly, you will help prevent any possible damage to the environment and to human health, which might otherwise be caused if it were disposed of in the wrong way.

The symbol on the product indicates that it may not be treated as normal household waste. It should be taken to a collection point for the recycling of electrical and electronic goods.

This appliance requires specialist waste disposal. For further information regarding the treatment, recovery and recycling of this product please contact your local council, your household waste disposal service, or the shop where you purchased it.